

# RoboStarter Kids Essential Module 2025

*The Future of Robots  
(Space Robot)*

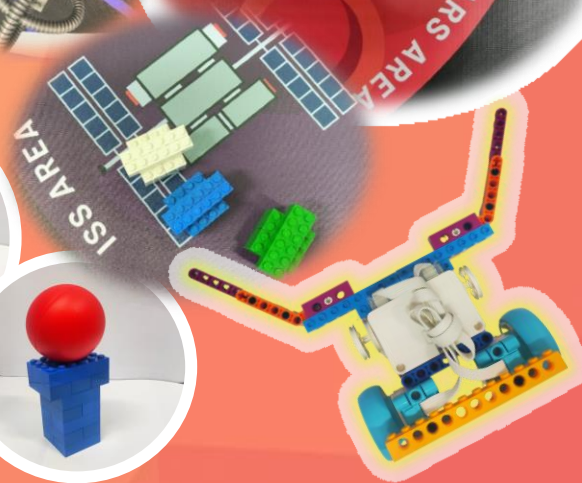
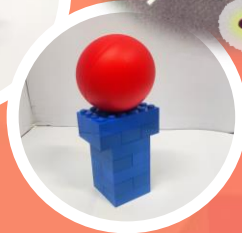
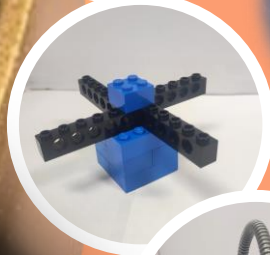
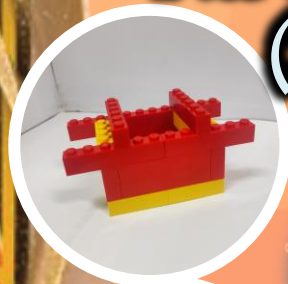

LEGO® Education SPIKE™ Essential

<https://www.spedip.com/bidang-stem.html>

DR HU LAEY NEE, DR NORSARIHAN AHMAD, VUN XIU XUAN,  
LAI CHAUN CHOY, ALVIN KONG WEI EE, TONY LOH LI JIN



# RoboStarter Kids Essential Module 2025

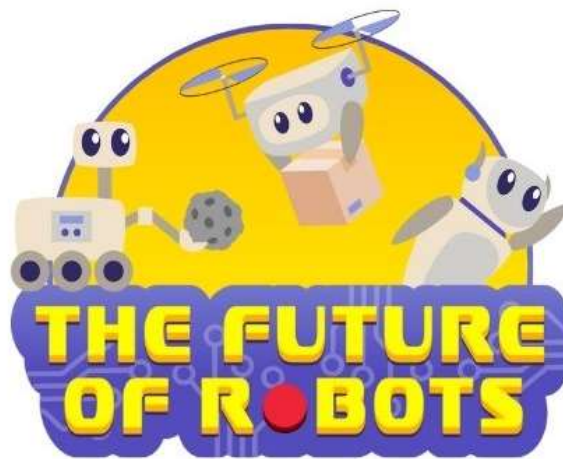

## *The Future of Robots (Space Robot)*



Ministry Of Education, Innovation & Talent Development, Sarawak  
Kementerian Pendidikan, Inovasi Dan Pembangunan Bakat  
Sarawak



*Institute of Teacher Education, Sarawak Campus, Miri*  
Institut Pendidikan Guru Kampus Sarawak, Miri

## **ADVISORS**

TUAN HAJI ADANA BIN HAJI JED

*Permanent Secretary, Ministry Of Education, Innovation & Talent Development, Sarawak*

DR HAJAH NORAINI BINTI HAJI OMAR

*Director, Institute of Teacher Education, Sarawak Campus, Miri*

ANIELIA ANAK SIAM

*Deputy Permanent Secretary, Ministry Of Education, Innovation & Talent Development, Sarawak*

Dr TIWI BINTI KAMIDIN

*Deputy Director, Institute of Teacher Education, Sarawak Campus, Miri*

## **COORDINATORS**

Dr HU LAEY NEE

*Head of Mathematics Unit, Department of Science, Technology, Engineering and Mathematics*

Dr NORSARIHAN BIN AHMAD

*Head of Department, Department of Planning, Research and Innovation Department*

## **TEAM MEMBERS**

VUN XIU XUAN

LAI CHAUN CHOY

TONY LOH LI JIN

ALVIN KONG WEI EE

---

**RoboStarter Kids Essential Module 2025** with the theme “The Future of Robots (Space Robot)”, Institute of Teacher Education, Sarawak Campus, Miri and Ministry Of Education, Innovation & Talent Development, Sarawak is published as a **robotics teaching and learning module using LEGO® Education SPIKE™ Essential to prepare young learners for the RoboStarter Kids Competition @ iCERI2025**. This module is specially designed to support early exposure to STEM among primary school students in an engaging and inclusive way.

---

Copyright © 2025 by Institute of Teacher Education, Sarawak Campus, Miri and Ministry Of Education, Innovation & Talent Development, Sarawak

e ISBN 978-967-2830-81-8

Partial reproduction of contents in any form and means, be it electronically, photocopying, mechanically, recordings or any other means is prohibited before written permission is requested from the Director, Institute of Teacher Education Malaysia, Sarawak Campus, Miri.

### **Published by**

Institut Pendidikan Guru Kampus Sarawak,  
Jalan Bakam, 98009 Miri, Sarawak.

### **In Collaboration with**

Ministry Of Education, Innovation & Talent Development, Sarawak,  
3rd, 4th & 11th Floor, LCD Tower,  
Lot 2879, The Isthmus, Off Jalan Bako,  
93050 Kuching, Sarawak.

## Preface

Introducing robotics to young learners can be both exciting and challenging, especially for those just beginning their journey in STEM. Many of these students require structured guidance to understand foundational concepts. The **RoboStarter Kids Essential Module 2025** with theme “The Future of Robots (Space Robot)” is developed to support this journey, offering an inclusive and engaging platform through the use of **LEGO® Education SPIKE™ Essential**.

This module is designed in alignment with the **RoboStarter Kids Competition @ iCERi2025**, which promotes a friendly, theme-based approach to robotics. It aims to build students’ confidence and creativity by combining hands-on robot construction, basic programming skills, and collaborative problem-solving. The module provides students with opportunities to explore robotics in a playful, supportive environment by laying the groundwork for progression into more advanced competitions.

The Mathematics Unit, Department of Science, Technology, Engineering, and Mathematics (STEM), and the Department of Planning, Research, and Innovation (JPPI) at the Institute of Teacher Education Malaysia, Sarawak Campus, Miri, together with four trainee teachers from the Programme of Bachelor of Teaching (Malay Language Primary Education) intake September 2021 – July 2026 specializing in Malay Language with electives in Mathematics, Science, or Physical Education, have collaboratively developed the **RoboStarter Kids Essential Module 2025**. This publication serves as a practical guide and reference for educators and students participating in beginner-level robotics programs and competition. It encourages exploration, innovation, and joyful learning through meaningful integration of robotics in early education.

We welcome any suggestions, improvements, or feedback to further enhance the quality and impact of this module. Any suggestions or ideas can be directed to Dr. Hu Laey Nee via email at [huln1234@gmail.com](mailto:huln1234@gmail.com).

Unit Matematik, Jabatan Sains, Teknologi, Kejuruteraan dan Matematik (JSTEM); dan  
Jabatan Perancangan, Penyelidikan dan Inovasi (JPPI)  
Institut Pendidikan Guru Malaysia Kampus Sarawak,  
Jalan Bakam, 98009 Miri,  
Sarawak, Malaysia  
Tel: 085-421201  
Faks: 085-424178

## Content of RoboStarter Kids Essential Module 2025

---

	Page
<b>1.0 ROBOSTARTER AND ROBOT CONTROL</b>	1
1.1 Software Integration for Program Control	1
1.2 Guide to Connect Bluetooth SPIKE to Devices	3
<b>2.0 BUILDING INSTRUCTION OF ROBOT</b>	6
<b>3.0 PROGRAMMING OF ROBOT</b>	6
3.1 Game Field with Labelled Game Elements	6
3.2 Programming Guide for Robot Missions	7
3.2.1 Mars Reunion	7
3.2.2 Bring Supplies to Astronauts	8
3.2.3 Growing Vegetables on The Moon	11
3.2.4 Clean Up Debris in Space and Bring a Spare Part to The Satellite	13
3.2.5 Bring The Astronauts Safely Back To Earth	17
3.2.6 Get Bonus Points And Avoid Penalties	22
<b>APPENDIX 1 : Building Instruction of the Spike Essential Robot</b>	23

## 1.0 ROBOSTARTER AND ROBOT CONTROL

RoboStarter is a platform or tool designed to help individuals, especially beginners, learn robotics, coding, and electronics through hands-on projects. Robot control refers to the way players control the movements of the robots. Robot can be controlled using devices such as laptop.

### 1.1 Software Integration for Program Control

Here's a step-by-step guide to download and integrate the Lego Education SPIKE™ software for the laptop. This application is designed to work seamlessly with both the LEGO® Education SPIKE™ Essential Set and LEGO® Education SPIKE™ Prime Set, providing a platform for students to engage in coding and robotics activities.

<p style="text-align: center;"><b>QR Code</b></p> 	<p><b>Link:</b> <a href="https://education.lego.com/en-us/downloads/spike-app/software/">https://education.lego.com/en-us/downloads/spike-app/software/</a></p>
--------------------------------------------------------------------------------------------------------------------------------------	---------------------------------------------------------------------------------------------------------------------------------------------------------------------

1. Download the version that matches the device (Windows, macOS, iPadOS, Android, or Chromebook).



2. Install the SPIKE™ App by opening the downloaded file.

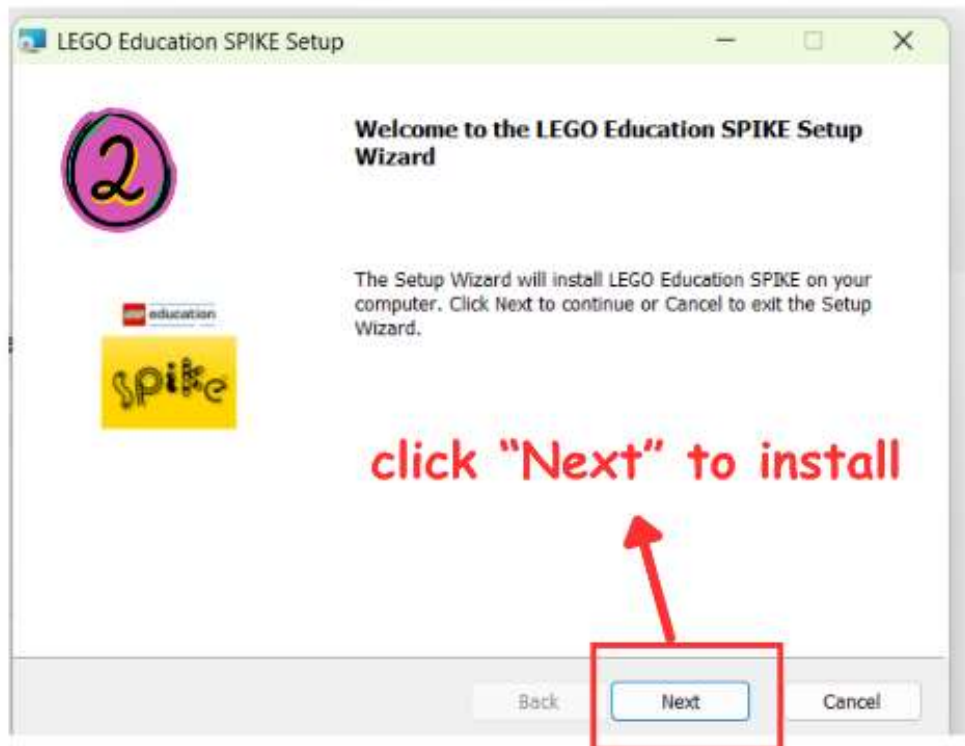

3. Wait for the installation process to complete

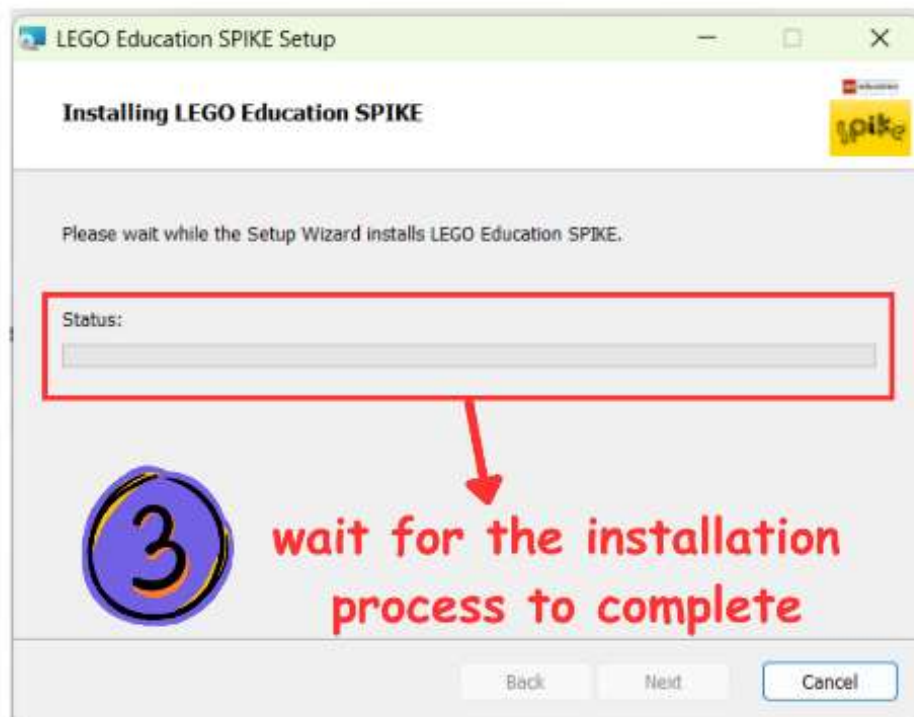

- Click "Finish" after the installation process is completed.



## 1.2 Guide To Connect Bluetooth SPIKE To The Devices

The LEGO® Education SPIKE™ Essential set can be connected to the controller via Bluetooth or USB. Here are the steps to connect the LEGO® Education SPIKE™ Essential to the controller.

Instruction	Example diagram
<p><b>1. Turn on the Spike hub</b></p> <ul style="list-style-type: none"> <li>Press and hold the centre button until the light turns on</li> </ul>	

**2. Launch the LEGO® Education SPIKE™ App on the laptop**

- Choose Spike Essential as the hub type



**3. Create a new project**

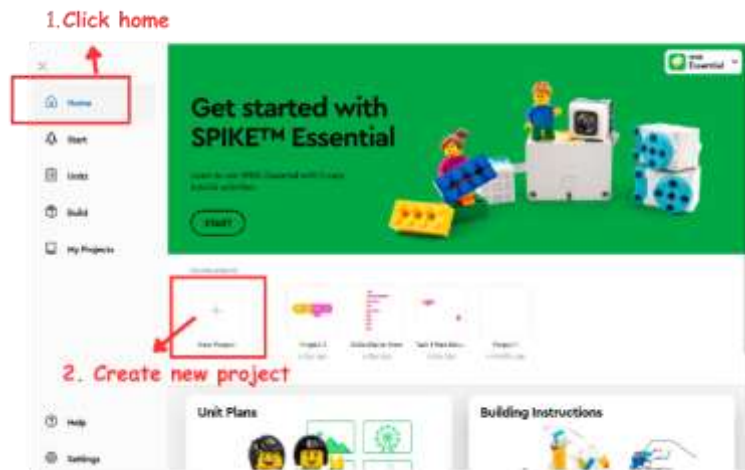

- Can create a new project or an existing project

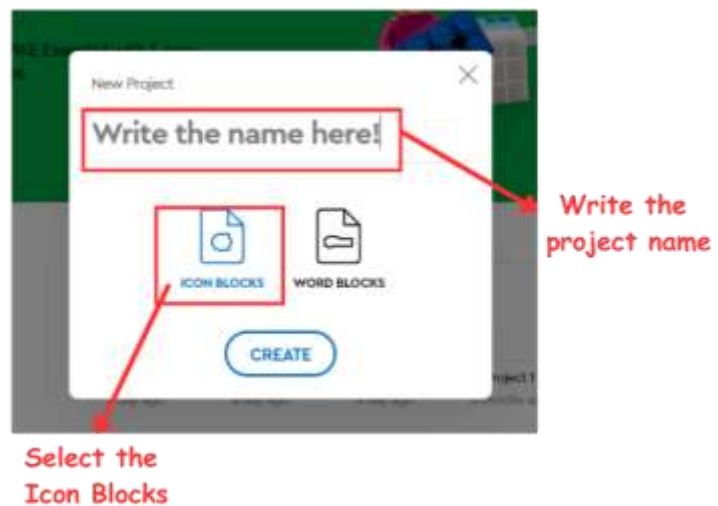

**4. Name the project**

- Select the Icon Blocks after the project is named

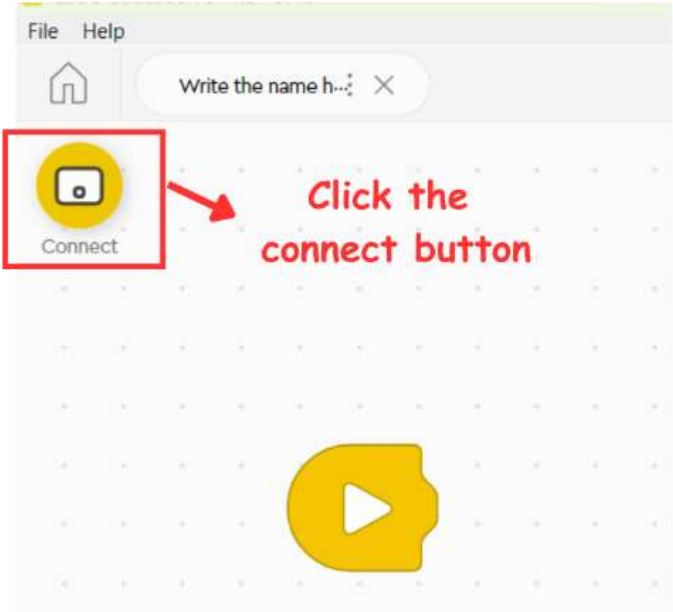

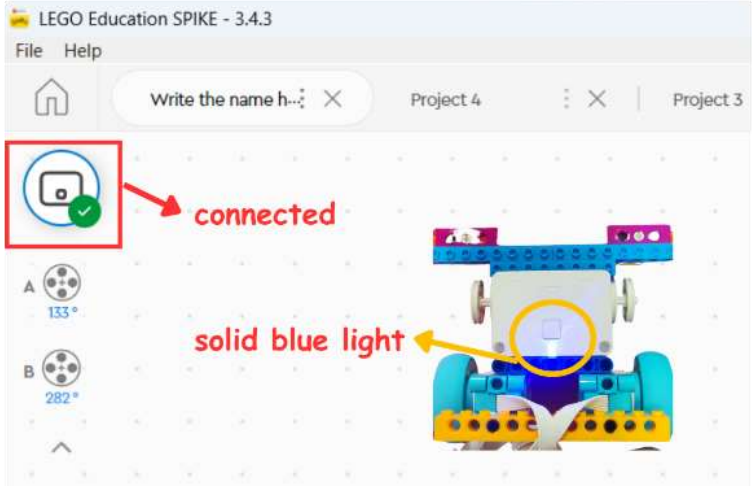
<p><b>5. Click the “Hub Connection” icon</b></p> <ul style="list-style-type: none"> <li>It looks like a small hub and make sure the Bluetooth of the laptop is turned on</li> </ul>	
<p><b>6. Click on the correct hub name</b></p> <ul style="list-style-type: none"> <li>Connection may take several seconds</li> </ul>	
<p><b>7. Confirm the connection</b></p> <ul style="list-style-type: none"> <li>The hub's centre light will turn solid blue when connected.</li> <li>If the hub does not show up, restart the app or turn bluetooth on laptop off and on again</li> </ul>	

## 2.0 BUILDING INSTRUCTION OF ROBOT

This section provides detailed building instructions for the robot module designed using the LEGO Education SPIKE Essential Set. To facilitate easy access, the complete building guide is provided in a PDF format and can be downloaded by scanning the provided QR code or clicking the link. For convenience, the instructions are also included in the appendix of this module (Appendix 1).

<p><b>Link</b>  <a href="https://drive.google.com/file/d/1xDN0fA77aYICBrVo2BEMAR62yMOB0UZI/view?usp=sharing">https://drive.google.com/file/d/1xDN0fA77aYICBrVo2BEMAR62yMOB0UZI/view?usp=sharing</a></p>	<p><b>QR Code</b></p> 
-------------------------------------------------------------------------------------------------------------------------------------------------------------------------------------------------------------	----------------------------------------------------------------------------------------------------------

## 3.0 PROGRAMMING OF ROBOT

This section presents a detailed vision of the game field, featuring clearly labelled game elements, accompanied by a structured programming guide.

### 3.1 Game Field With Labelled Game Elements

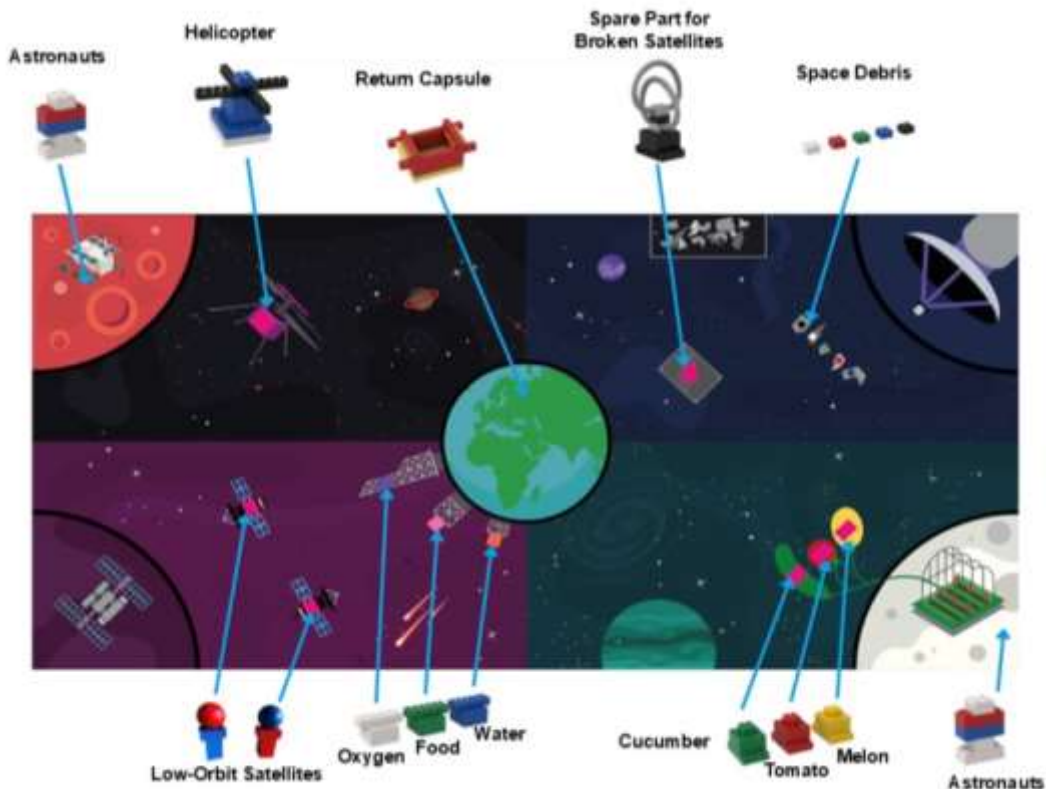

### 3.2 Programming Guide for Robot Missions

This part showcases the programming guide that assist the robot to complete each mission on the game field. It provides easy-to-follow steps, showing which coding blocks to use and how to put them together.

#### 3.2.1 Mars Reunion (10 points)

On Mars, there are two robots, a helicopter and a rover. A strong storm caused them to lose each other, and now the helicopter is far away! Your robot's mission is to help the helicopter find the Mars rover. Can you help them find each other and work together again?

**Mission:**

**Bring the helicopter to the Mars corner.** Points are only given if the helicopter is completely inside the Mars corner and not damaged – the line belongs to the corner.

- Definition “completely in”: Completely means that the game object is touching the corresponding area only.

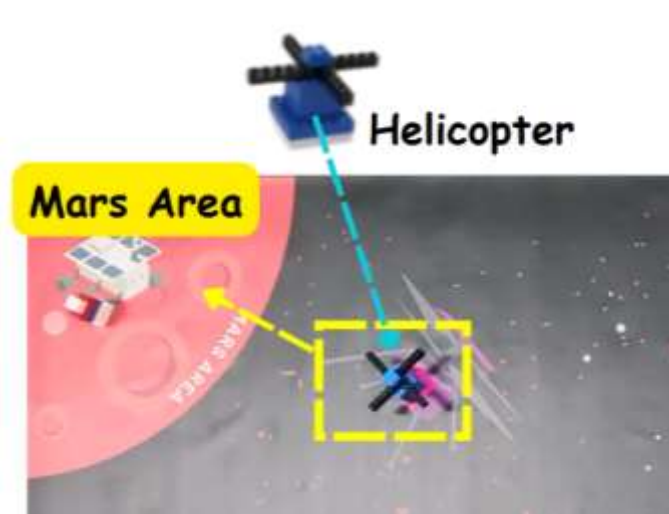



#### Step-by-step Programming Guide

Block	Name of the block	Function of the block
1	Play Block	<ul style="list-style-type: none"> <li>• This block will play all the blocks that are attached to it. When the Play Button in the bottom right corner is pressed, all the Play Blocks will start simultaneously.</li> </ul>

2	<b>Movement Speed Block</b>	<ul style="list-style-type: none"> <li>Place this block in front of the other Movement Blocks. It will change the speed of the Driving Base from then on onwards.</li> <li>This block changes the speed of moving a Driving Base. The speed levels can be set to 15%, 40%, 70% or 100%. The speed is set to be 100%.</li> </ul>
3	<b>Move Forward Block</b>	<ul style="list-style-type: none"> <li>This block moves a Driving Base forward a number of wheel rotations.</li> <li>To change the number of wheel rotations, press the number on the block. The Driving Base is set to move forward for 7.5 full rotations.</li> </ul>
Sample mission video		<a href="https://youtu.be/nGcYWj7EeFE">https://youtu.be/nGcYWj7EeFE</a>

**Scoring of Mission (Mars Reunion):**

 <p>10 points (Helicopter is completely in the Mars Corner and is not damaged)</p>	 <p>0 point (partly outside)</p>	 <p>10 points (object is completely inside although the robot is partly touching the Mars Corner)</p>
---------------------------------------------------------------------------------------------------------------------------------------------------------------------------	--------------------------------------------------------------------------------------------------------------------------	------------------------------------------------------------------------------------------------------------------------------------------------------------------------------------------------

**3.2.2 Bring Supplies to Astronauts (30 points)**

If astronauts are going to settle on the Moon, or explore further reaches of our Solar System, they will need air, food and water. Currently, the only human outpost is the International Space Station (ISS).

ISS is supplied with water and food from Earth. Each astronaut needs approximately 1 kg of oxygen, 1 kg of dehydrated food and 3 kg of water per day.

**Mission:**

1. **Deliver the supplies** (blue for water, green for food, and white for oxygen) to the ISS Corner.
  - The elements must start from their platforms on Earth. To score points, each element must be inside or touching the Space Station Corner and must not be damaged.
2. **Avoid the low-orbit satellites.** They must not be moved or damaged.

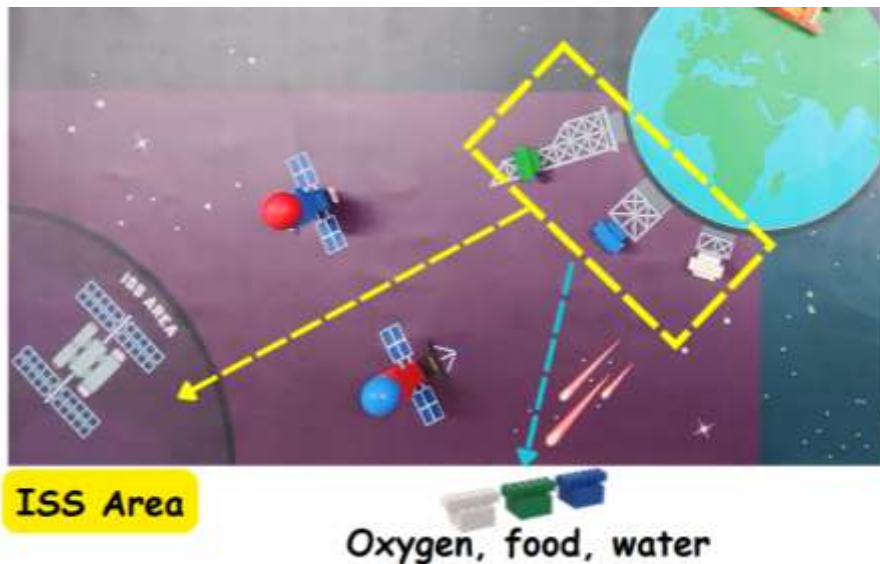



**Step-by-step Programming Guide**

Block	Name of the block	Function of the block
1	Play Block	<ul style="list-style-type: none"> <li>• This block will play all the blocks that are attached to it. When the Play Button in the bottom right corner is pressed, all the Play Blocks will start simultaneously.</li> </ul>
2	Movement Speed Block	<ul style="list-style-type: none"> <li>• Place this block in front of the other Movement Blocks. It will change the speed of the Driving Base from then on onwards.</li> <li>• This block changes the speed of moving a Driving Base. The speed levels can be set to 15%, 40%, 70% or 100%. The speed is set to be 100%.</li> </ul>

3	<b>Move Forward Block</b>	<ul style="list-style-type: none"> <li>• This block moves a Driving Base forward a number of wheel rotations.</li> <li>• To change the number of wheel rotations, press the number on the block. The Driving Base is set to move forward for 2 full rotations.</li> </ul>
4	<b>Turn Clockwise Block</b>	<ul style="list-style-type: none"> <li>• This block turns a Driving Base clockwise.</li> <li>• To change how much the Driving Base should turn, press the number on the block. The Driving Base is set to rotate clockwise for 1.3 rotations.</li> </ul>
5	<b>Move Forward Block</b>	<ul style="list-style-type: none"> <li>• The rotation is set to move forward for 1.8 rotation.</li> </ul>
6	<b>Turn Clockwise Block</b>	<ul style="list-style-type: none"> <li>• The Driving Base is set to rotate clockwise for 1 rotation.</li> </ul>
7	<b>Move Forward Block</b>	<ul style="list-style-type: none"> <li>• The rotation is set to move forward for 3.5 rotation.</li> </ul>
8	<b>Movement Speed Block</b>	<ul style="list-style-type: none"> <li>• The speed is set to be 70%.</li> </ul>
9	<b>Turn Counterclockwise Block</b>	<ul style="list-style-type: none"> <li>• This block turns a Driving Base counterclockwise.</li> <li>• To change how much the Driving Base should turn, press the number on the block. The Driving Base is set to rotate counterclockwise for 2.7 rotations.</li> </ul>
10	<b>Movement Speed Block</b>	<ul style="list-style-type: none"> <li>• The speed is set to be 70%.</li> </ul>
11	<b>Move Forward Block</b>	<ul style="list-style-type: none"> <li>• The rotation is set to move forward for 4.5 rotation.</li> </ul>
Sample mission video		<a href="https://youtu.be/zmfl3BSFKOk">https://youtu.be/zmfl3BSFKOk</a>

**Scoring of Mission (Bring Supplies to Astronauts):**

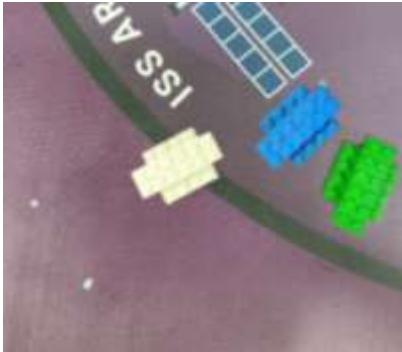
 <p>3 x 10 points = 30 points (The supply elements are completely in the ISS corner, and not damaged)</p>	 <p>0 points (Outside the ISS Area)</p>
 <p>3 x 5 points = 15 points (Three supply elements are partly inside in the ISS corner, and not damaged)</p>	 <p>2 x 10 points + 1 x 5 points = 25 points (Two supply elements are completely and one supply elements partly inside in the ISS corner, and not damaged)</p>

**3.2.3 Growing Vegetables on The Moon (30 points)**

Supplying 5 kg of supplies per astronaut per day from Earth is costly and impractical for long duration space missions, so scientists are researching how to create a closed life support system could be used in space.

Such a life support system is essential for further space exploration and will also help us improve the way we use resources on Earth.

**Mission:**

1 red element for tomato, 1 green element for cucumber and 1 yellow element for melon are placed in the corresponding squares in front of the Moon corner.

1. **Bring the elements to the greenhouse on the Moon.** Points are only given if the elements are inside or touching the greenhouse and not damaged – the lines belong to the greenhouse.





### Step-by-step Programming Guide

Block	Name of the block	Function of the block
1	Play Block	<ul style="list-style-type: none"> <li>This block will play all the blocks that are attached to it. When the Play Button in the bottom right corner is pressed, all the Play Blocks will start simultaneously.</li> </ul>
2	Movement Speed Block	<ul style="list-style-type: none"> <li>Place this block in front of the other Movement Blocks. It will change the speed of the Driving Base from then on onwards.</li> <li>This block changes the speed of moving a Driving Base. The speed levels can be set to 15%, 40%, 70% or 100%. The speed is set to be 100%.</li> </ul>
3	Move Forward Block	<ul style="list-style-type: none"> <li>This block moves a Driving Base forward a number of wheel rotations.</li> <li>To change the number of wheel rotations, press the number on the block. The Driving Base is set to move forward for 6 full rotations.</li> </ul>
4	Turn Counterclockwise Block	<ul style="list-style-type: none"> <li>This block turns a Driving Base counterclockwise.</li> <li>To change how much the Driving Base should turn, press the number on the block. The Driving Base is set to rotate counterclockwise for 1 rotation.</li> </ul>

<b>5</b>	<b>Move Forward Block</b>	<ul style="list-style-type: none"> <li>The Driving Base is set to move forward for 1.3 full rotations.</li> </ul>
<b>6</b>	<b>Turn Clockwise Block</b>	<ul style="list-style-type: none"> <li>This block turns a Driving Base clockwise.</li> <li>To change how much the Driving Base should turn, press the number on the block. The Driving Base is set to rotate clockwise for 1.6 rotations.</li> </ul>
<b>7</b>	<b>Move Forward Block</b>	<ul style="list-style-type: none"> <li>The Driving Base is set to move forward for 1.8 full rotations.</li> </ul>
<b>Sample mission video</b>		<a href="https://youtu.be/2mHu2wnXDts">https://youtu.be/ 2mHu2wnXDts</a>

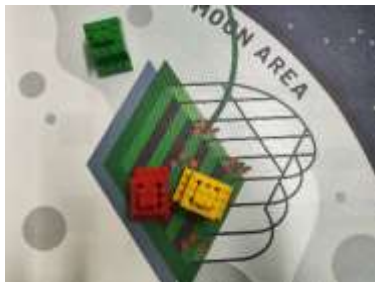
**Scoring of Mission (Growing Vegetables on The Moon):**

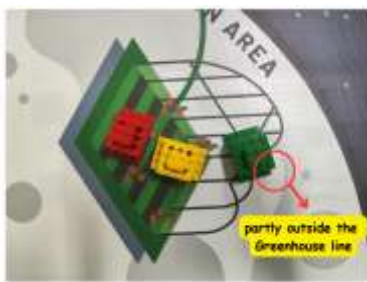
		
<p><b>22 points</b>                  (red and yellow game object are completely inside the Greenhouse)                  2 x 10 points = <b>20 points</b>                   (green game object is still completely inside the Moon Corner) - <b>2 points</b></p>	<p><b>30 points</b>                  (All the game object are completely inside the Greenhouse)                  3 x 10 points = <b>30 points</b></p>	<p><b>25 points</b>                  (red and yellow game object are completely inside the Greenhouse)                  2 x 10 points = <b>20 points</b>                   (green game object is partly inside the Greenhouse) - <b>5 points</b></p>

**3.2.4 Clean Up Debris in Space and Bring a Spare Part to The Satellite (40 points)**

In space there are communications satellites, weather satellites, and the International Space Stations. But what happens to a satellite once it has served its purpose? It continues to circle (orbit) around Earth!

Space debris, or space 'junk', refers to human-made objects that are orbiting the Earth but no longer serve a useful purpose.

**Missions:**

1. **Clean Up the Debris (25 points):** Clean up the debris in space by moving the five space debris pieces to the Waste Area. Points are given for each debris piece that is completely inside the Waste Area. Remember, the line is part of the area.



2. **Repair the Satellite (15 points):** After cleaning up, move the Spare Part to the Satellite Corner. Points are only given if the Spare Part is completely inside the Satellite Corner, not damaged, **AND** at least one debris piece is inside the Waste Area.





## Step-by-step Programming guide

### 1. Clean Up The Debris



Block	Name of the block	Function of the block
1	<b>Play Block</b>	<ul style="list-style-type: none"> <li>This block will play all the blocks that are attached to it. When the Play Button in the bottom right corner is pressed, all the Play Blocks will start simultaneously.</li> </ul>
2	<b>Movement Speed Block</b>	<ul style="list-style-type: none"> <li>Place this block in front of the other Movement Blocks. It will change the speed of the Driving Base from then on onwards.</li> <li>This block changes the speed of moving a Driving Base. The speed levels can be set to 15%, 40%, 70% or 100%. The speed is set to be 100%.</li> </ul>
3	<b>Move Forward Block</b>	<ul style="list-style-type: none"> <li>This block moves a Driving Base forward a number of wheel rotations.</li> <li>To change the number of wheel rotations, press the number on the block. The Driving Base is set to move forward for 7 full rotations.</li> </ul>
4	<b>Move Backward Block</b>	<ul style="list-style-type: none"> <li>This block moves a Driving Base backward a number of wheel rotations.</li> <li>To change the number of wheel rotations, press the number on the block. The Driving Base is set to move backward for 3.5 full rotations.</li> </ul>
5	<b>Turn Clockwise Block</b>	<ul style="list-style-type: none"> <li>The Driving Base is set to rotate clockwise for 1.2 rotation.</li> </ul>
6	<b>Move Backward Block</b>	<ul style="list-style-type: none"> <li>The Driving Base is set to move backward for 5 full rotations.</li> </ul>



<p>Sample mission video</p>		<p><a href="https://youtu.be/Eyq1p8GzEml">https://youtu.be/Eyq1p8GzEml</a></p>
-----------------------------	-----------------------------------------------------------------------------------	--------------------------------------------------------------------------------

## 2. Repair The Satellite

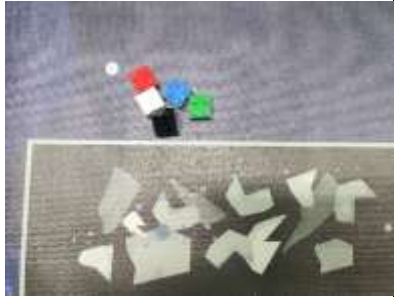
		
Block	Name of the block	Function of the block
1	Play Block	<ul style="list-style-type: none"> <li>This block will play all the blocks that are attached to it. When the Play Button in the bottom right corner is pressed, all the Play Blocks will start simultaneously.</li> </ul>
2	Movement Speed Block	<ul style="list-style-type: none"> <li>Place this block in front of the other Movement Blocks. It will change the speed of the Driving Base from then on onwards.</li> <li>This block changes the speed of moving a Driving Base. The speed levels can be set to 15%, 40%, 70% or 100%. The speed is set to be 100%.</li> </ul>
3	Move Forward Block	<ul style="list-style-type: none"> <li>This block moves a Driving Base forward a number of wheel rotations.</li> <li>To change the number of wheel rotations, press the number on the block. The Driving Base is set to move forward for 8 full rotations.</li> </ul>
<p>Sample mission video</p>		<p><a href="https://youtu.be/wXbvyJmyQTq">https://youtu.be/wXbvyJmyQTq</a></p>

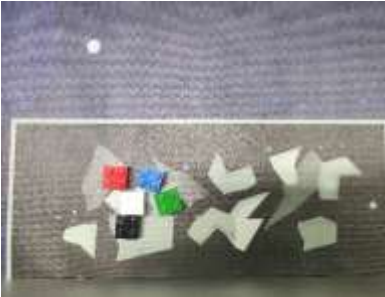
**Scoring of Mission (Clean Up Debris in Space and Bring a Spare Part to The Satellite):**

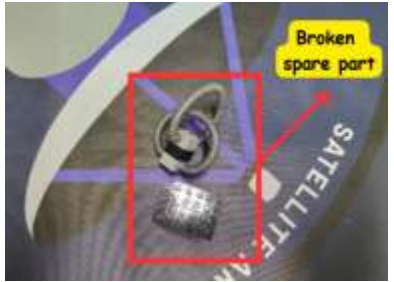
Scoring of Mission (Clean Up Debris in Space)		
 <p>0 point (All the space debris elements are completely outside the Waste Area)</p>	 <p>20 points (Red space debris is not completely inside the Waste Area) 4 x 5 points = 20 points</p>	 <p>25 points (All the space debris elements are completely inside the Waste Area) 5 x 5 points = 25 points</p>

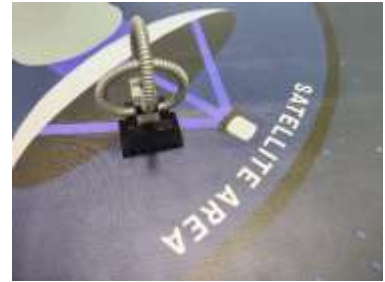
Scoring of Mission (Bring a Spare Part to The Satellite)		
 <p>0 point (The spare part is damaged although it is completely inside the Satellite Corner)</p>	 <p>0 point (The spare part is partly inside the Satellite Corner)</p>	 <p>15 points <b>(At least one debris element is inside the Waste area AND The Spare part is completely inside the Satellite corner, and is not damaged)</b></p>

**3.2.5 Bring The Astronauts Safely Back To Earth (40 points)**

Travelling in space is very dangerous. After completing a successful mission in space, your task is to bring the astronauts safely back to Earth!

Your robot must navigate the space station, secure the astronauts in the return capsule, and guide them through the journey back to Earth's surface.

**Mission:**

1. The robot must **move the capsule to Mars and the Moon**. The robot must operate autonomously. If the return capsule touches the Mars or Moon corners, the team is allowed to manually place the astronaut into the capsule.

- The robot must then **return the capsule to Earth**. Once the capsule touches Earth, the team should manually place the astronauts on Earth. Points are only given if astronauts are completely inside Earth and are not damaged.

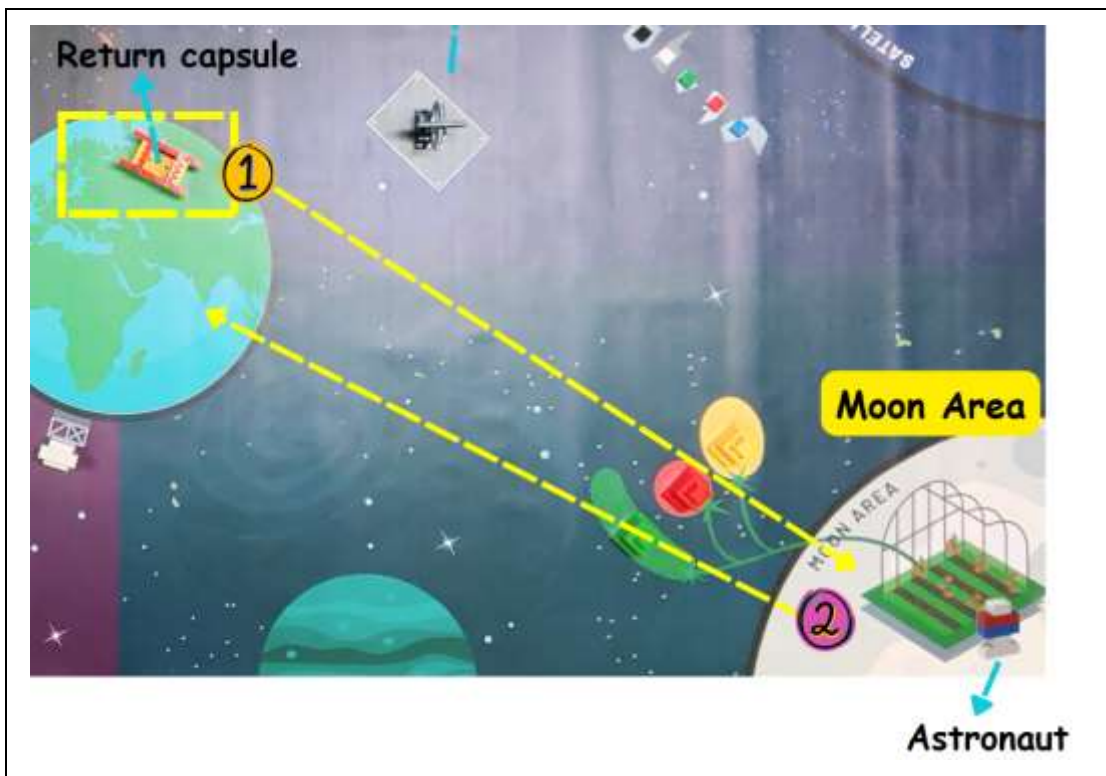
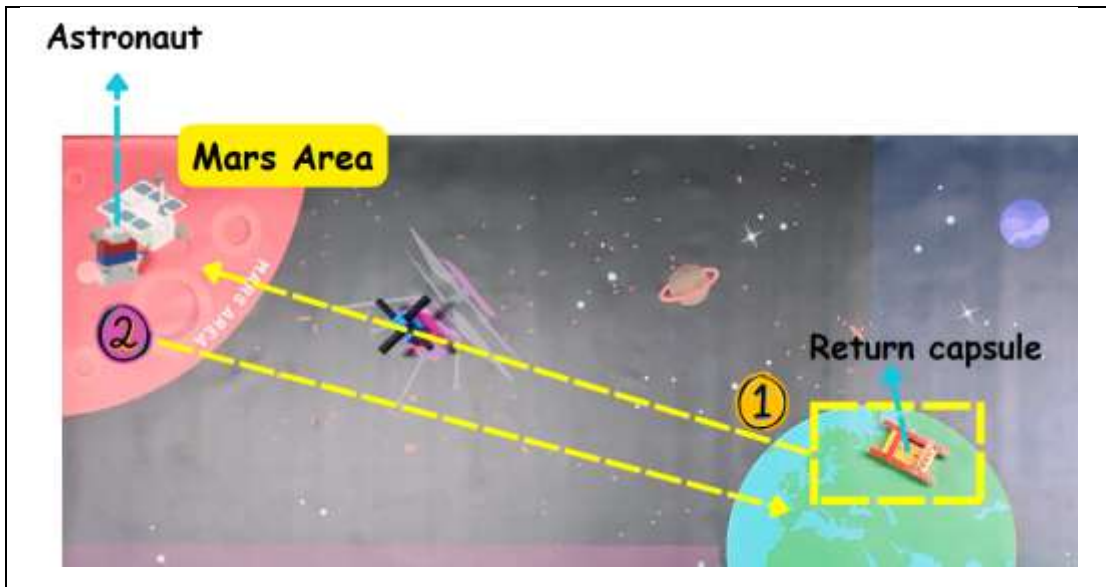

**Step-by-step Programming Guide**



**1. Move the capsule to Mars and back from Mars**

Block	Name of the block	Function of the block
1	<b>Play Block</b>	<ul style="list-style-type: none"> <li>This block will play all the blocks that are attached to it. When the Play Button in the bottom right corner is pressed, all the Play Blocks will start simultaneously.</li> </ul>
2	<b>Movement Speed Block</b>	<ul style="list-style-type: none"> <li>Place this block in front of the other Movement Blocks. It will change the speed of the Driving Base from then on onwards.</li> <li>This block changes the speed of moving a Driving Base. The speed levels can be set to 15%, 40%, 70% or 100%. The speed is set to be 100%.</li> </ul>
3	<b>Move Forward Block</b>	<ul style="list-style-type: none"> <li>This block moves a Driving Base forward a number of wheel rotations.</li> <li>To change the number of wheel rotations, press the number on the block. The Driving Base is set to move forward for 7 full rotations.</li> </ul>
1	<b>Play Block</b>	<ul style="list-style-type: none"> <li>This block will play all the blocks that are attached to it. When the Play Button in the bottom right corner is pressed, all the Play Blocks will start simultaneously.</li> </ul>



2	<b>Movement Speed Block</b>	<ul style="list-style-type: none"> <li>Place this block in front of the other Movement Blocks. It will change the speed of the Driving Base from then on onwards. This block changes the speed of moving a Driving Base. The speed levels can be set to 15%, 40%, 70% or 100%. The speed is set to be 100%.</li> </ul>
3	<b>Move Forward Block</b>	<ul style="list-style-type: none"> <li>This block moves a Driving Base forward a number of wheel rotations. To change the number of wheel rotations, press the number on the block. The Driving Base is set to move forward for 8 full rotations.</li> </ul>
Sample mission video		<a href="https://youtu.be/2_Ylex9Jqxc">https://youtu.be/2_Ylex9Jqxc</a>

**2. Move the capsule to Moon and back from Moon**

		
Block	Name of the block	Function of the block
1	<b>Play Block</b>	<ul style="list-style-type: none"> <li>This block will play all the blocks that are attached to it. When the Play Button in the bottom right corner is pressed, all the Play Blocks will start simultaneously.</li> </ul>
2	<b>Movement Speed Block</b>	<ul style="list-style-type: none"> <li>Place this block in front of the other Movement Blocks. It will change the speed of the Driving Base from then on onwards.</li> <li>This block changes the speed of moving a Driving Base. The speed levels can be set to 15%, 40%, 70% or 100%. The speed is set to be 100%.</li> </ul>
3	<b>Move Forward Block</b>	<ul style="list-style-type: none"> <li>This block moves a Driving Base forward a number of wheel rotations.</li> <li>To change the number of wheel rotations, press the number on the block. The Driving Base is set to move forward for 7 full rotations.</li> </ul>

		
1	<b>Play Block</b>	<ul style="list-style-type: none"> <li>This block will play all the blocks that are attached to it. When the Play Button in the bottom right corner is pressed, all the Play Blocks will start simultaneously.</li> </ul>
2	<b>Movement Speed Block</b>	<ul style="list-style-type: none"> <li>Place this block in front of the other Movement Blocks. It will change the speed of the Driving Base from then on onwards. This block changes the speed of moving a Driving Base. The speed levels can be set to 15%, 40%, 70% or 100%. The speed is set to be 100%.</li> </ul>
3	<b>Move Forward Block</b>	<ul style="list-style-type: none"> <li>This block moves a Driving Base forward a number of wheel rotations. To change the number of wheel rotations, press the number on the block. The Driving Base is set to move forward for 8 full rotations.</li> </ul>
Sample mission video		<a href="https://youtu.be/khr0zls0O-0">https://youtu.be/khr0zls0O-0</a>

**Scoring of Mission (Bring The Astronauts Safely Back To Earth)**

	
<p>20 points (One astronaut is completely inside the Earth area and not damaged)</p>	<p>40 points (Both astronauts are completely inside the Earth and not damaged)</p>

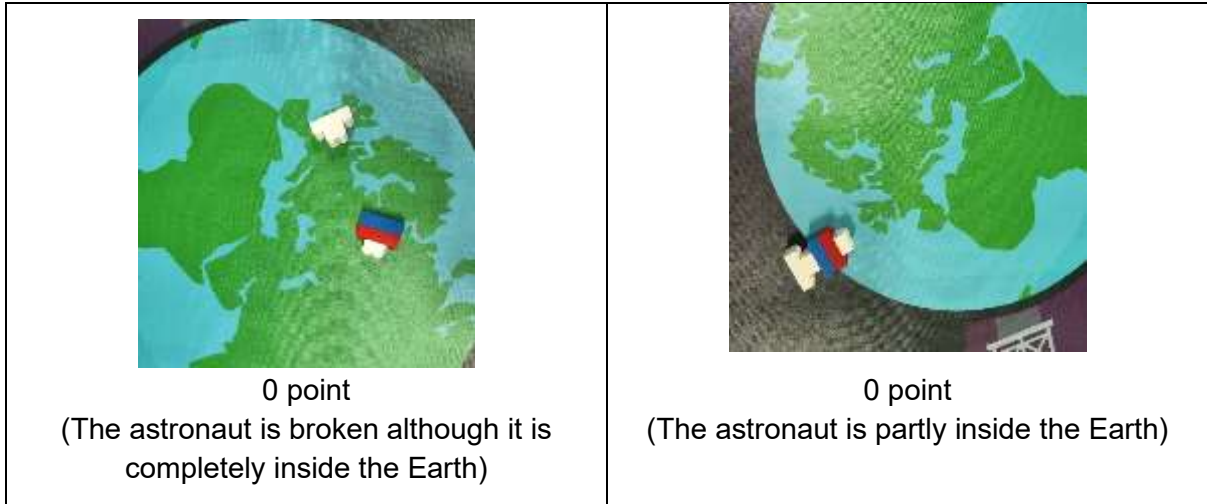

### 3.2.6 Get Bonus Points And Avoid Penalties (10 points)

BONUS POINTS are given only if other points are assigned. In another words, bonus points will only be given if points have been earned from at least one task. The following situation qualifies for the awarding of bonus points:

- If the low-orbit satellites are not moved or damaged.

However, penalties will also be applied. The points will be subtracted from the score unless the score becomes negative. The conditions below explain when penalties will apply:

- If a team illegally touches the robot (outside the four corners and the centre circle) or a game object a penalty of 1 point is subtracted from the total score.



**APPENDIX 1:**

**Building Instruction of the Spike Essential Robot**

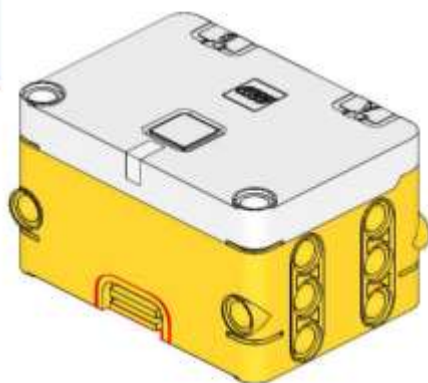
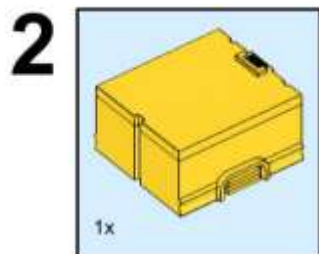
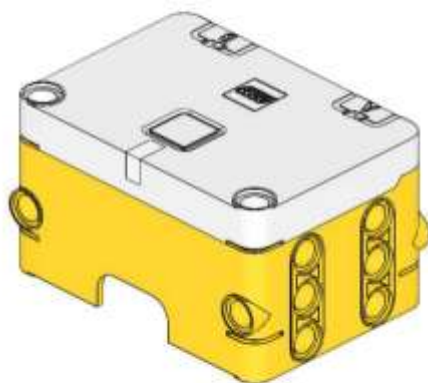
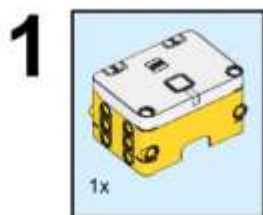

**3**  2x

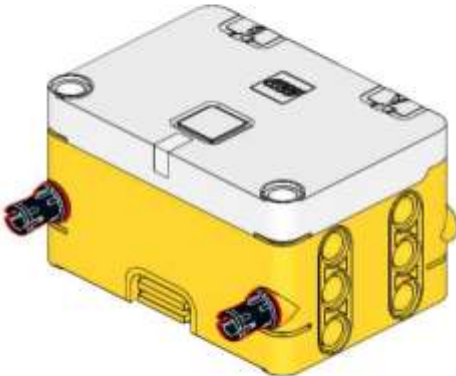

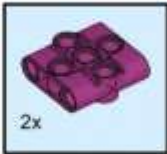
**4**  2x

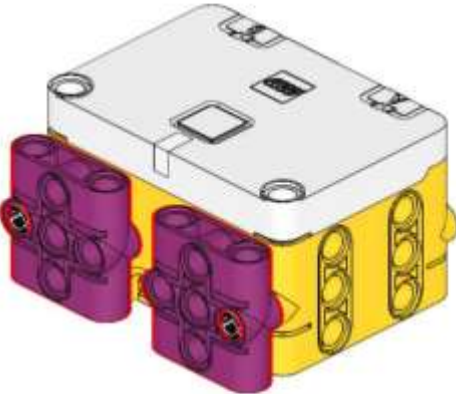

**5**  4x

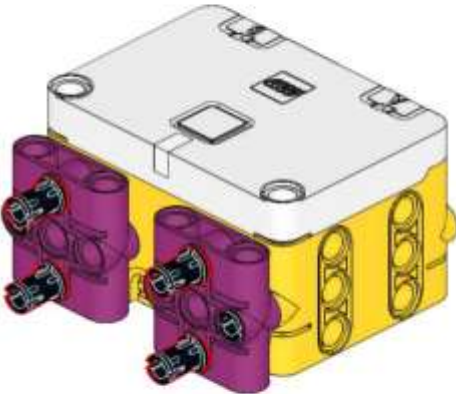

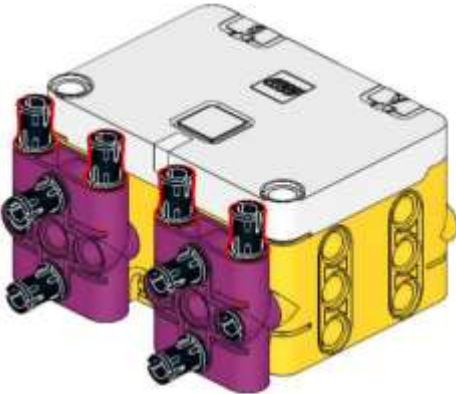

**6**  4x

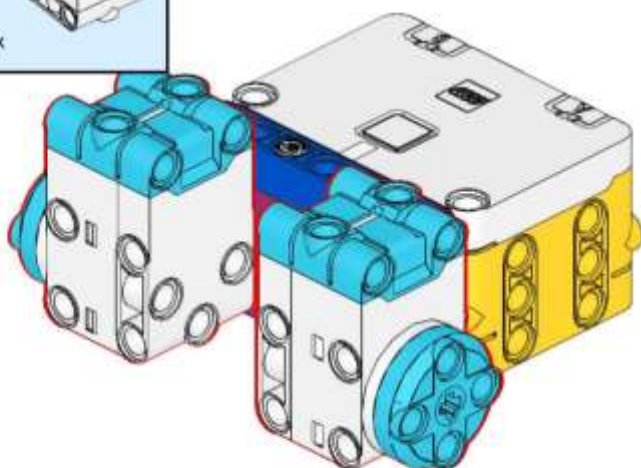
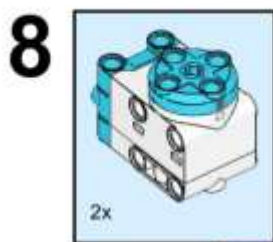
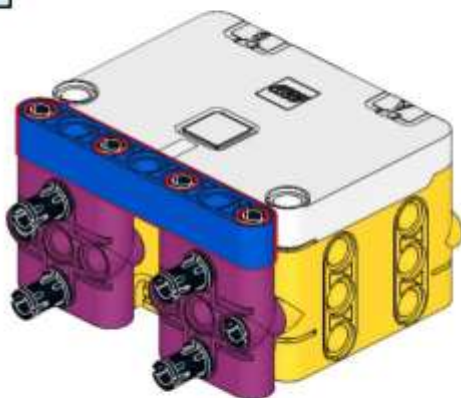
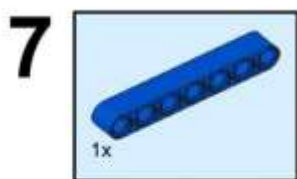

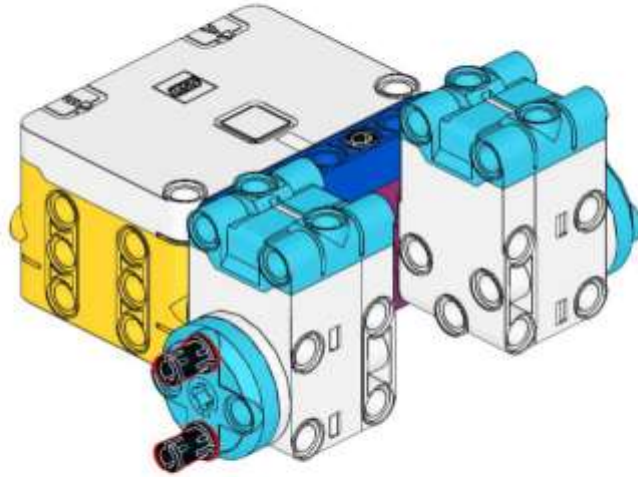

9  2x



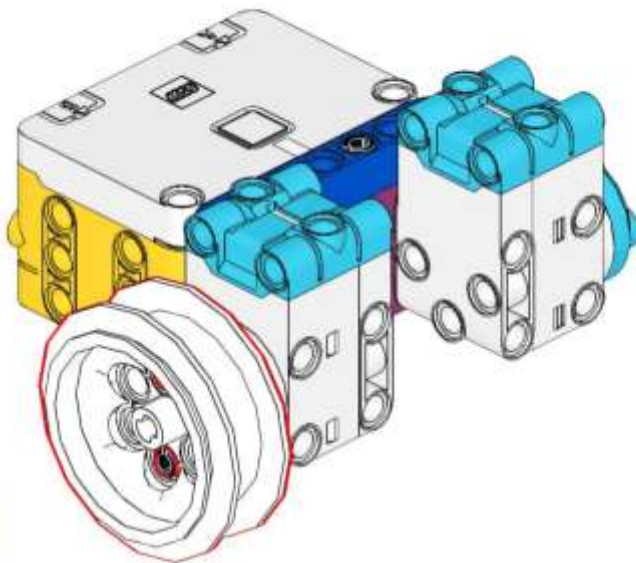

10  1x

Use this tyre in LEGO essential set

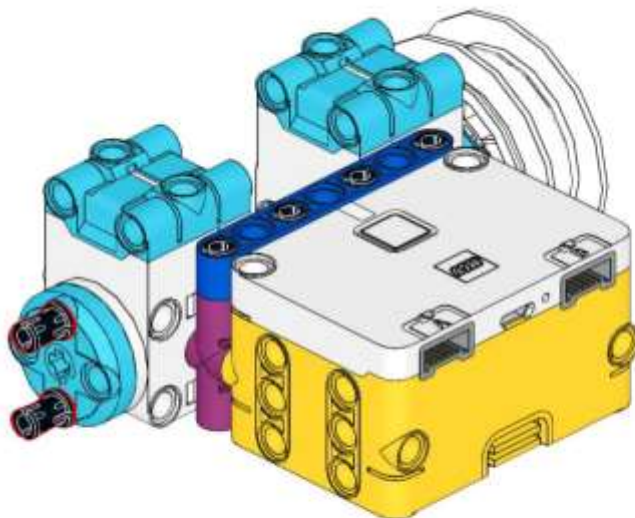

11  2x



12  1x

Use this tyre in LEGO essential set

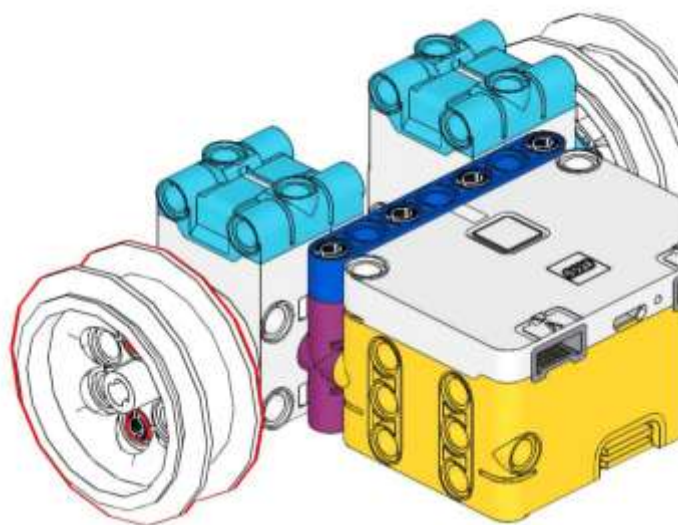

13

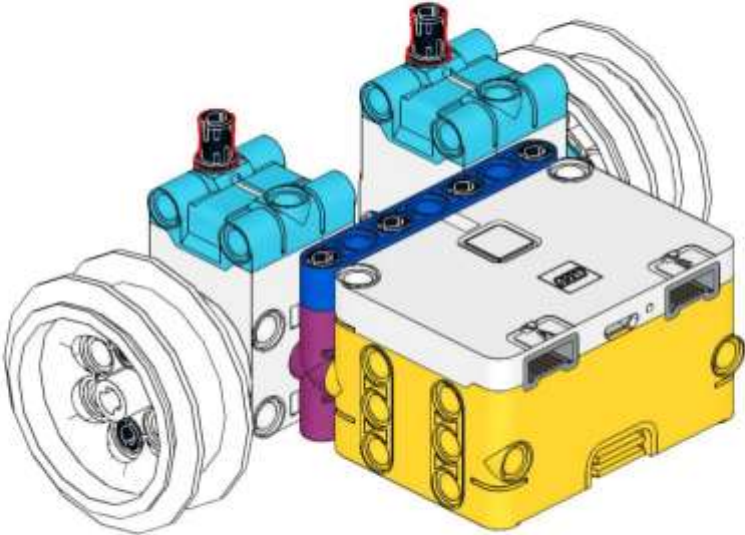

14

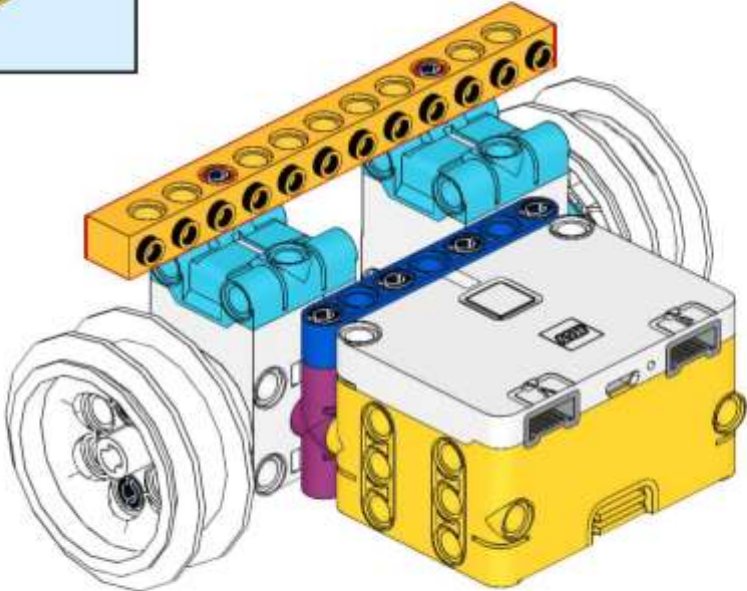
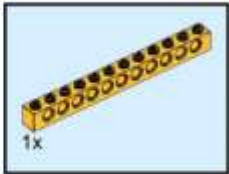

15

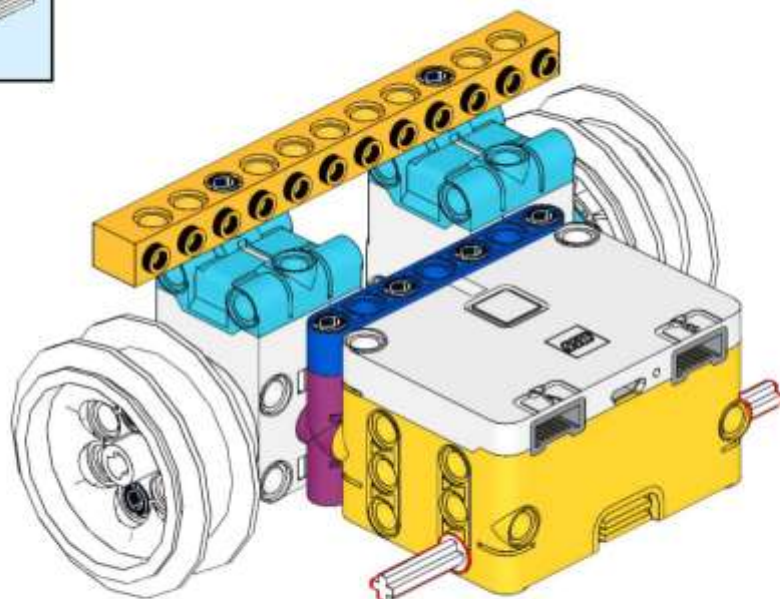

16

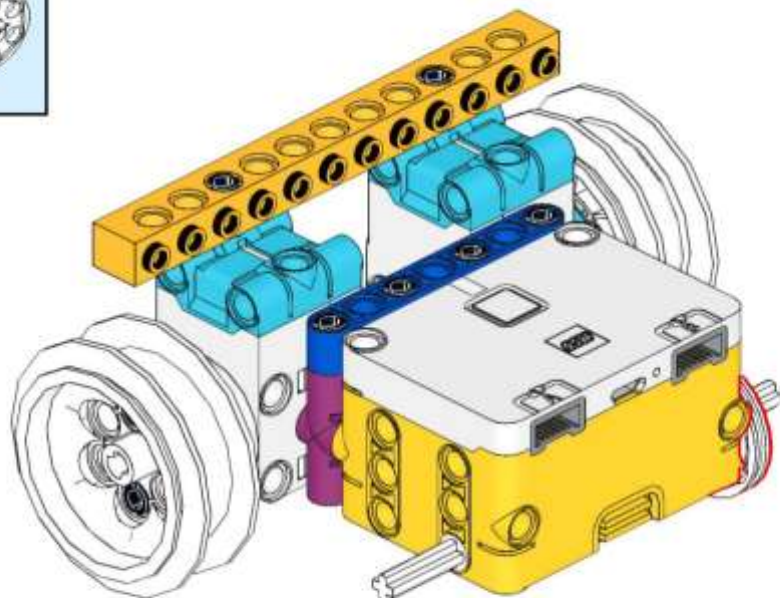

17  1x

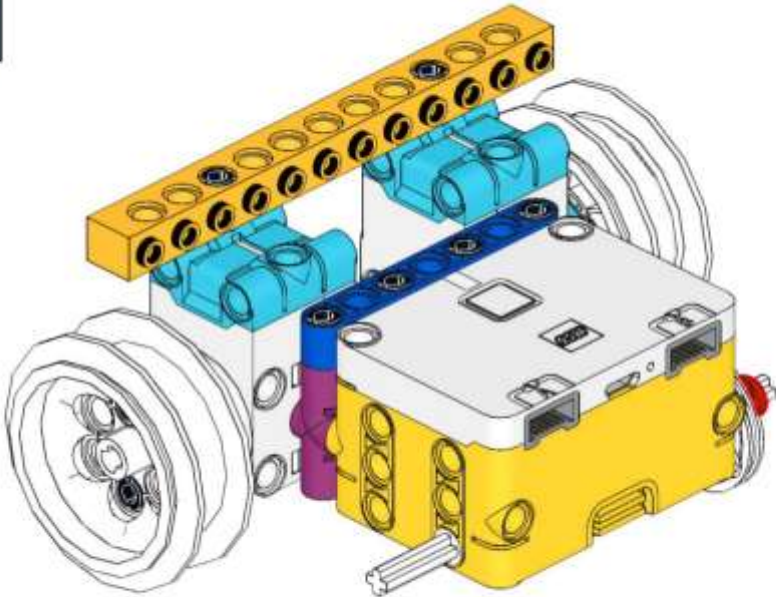

18  1x

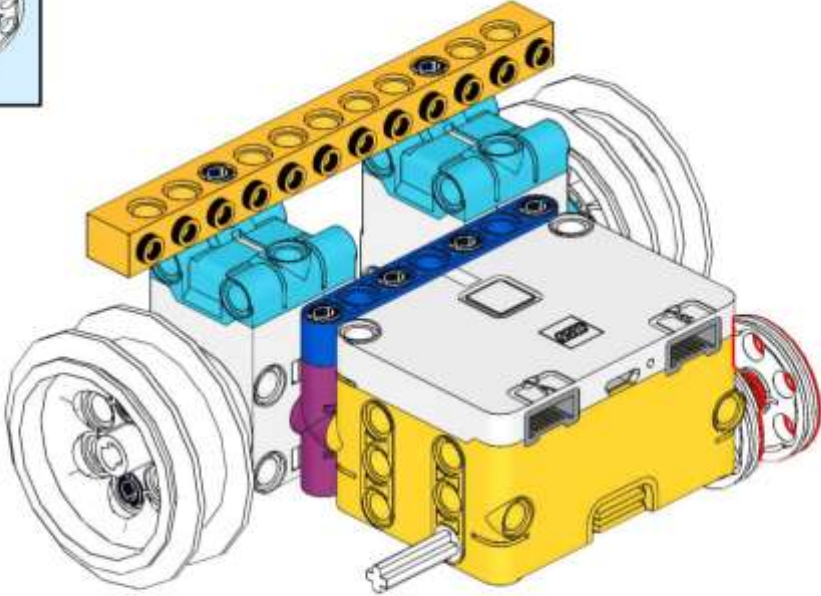

19

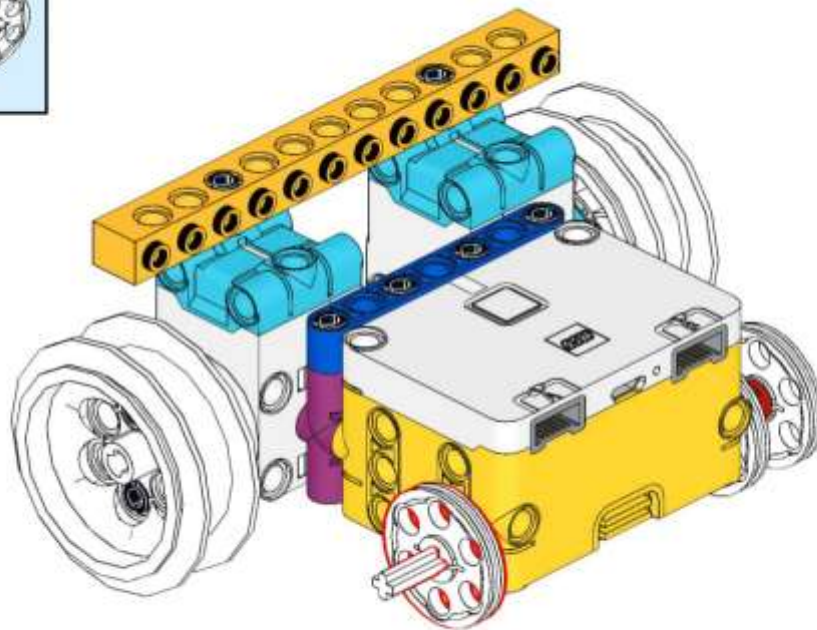

20

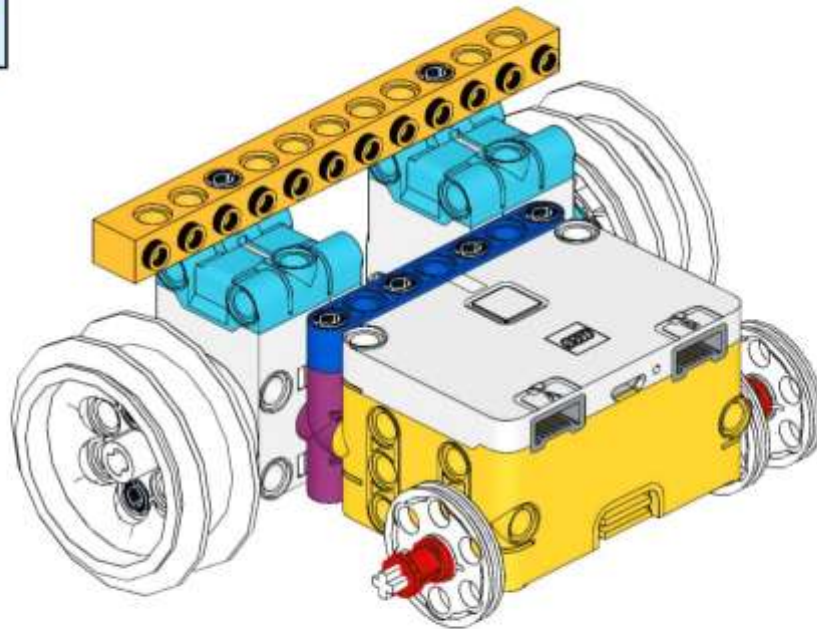

21

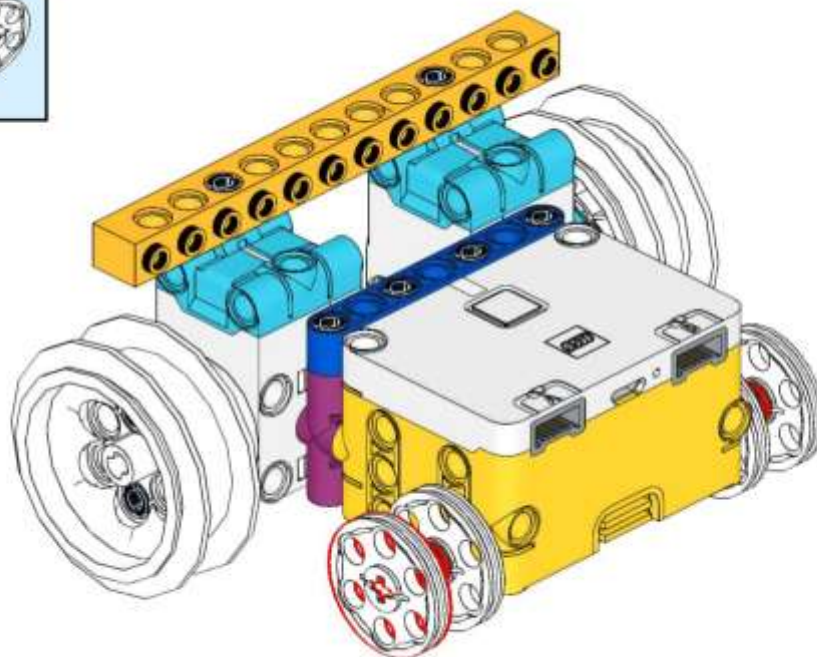

22

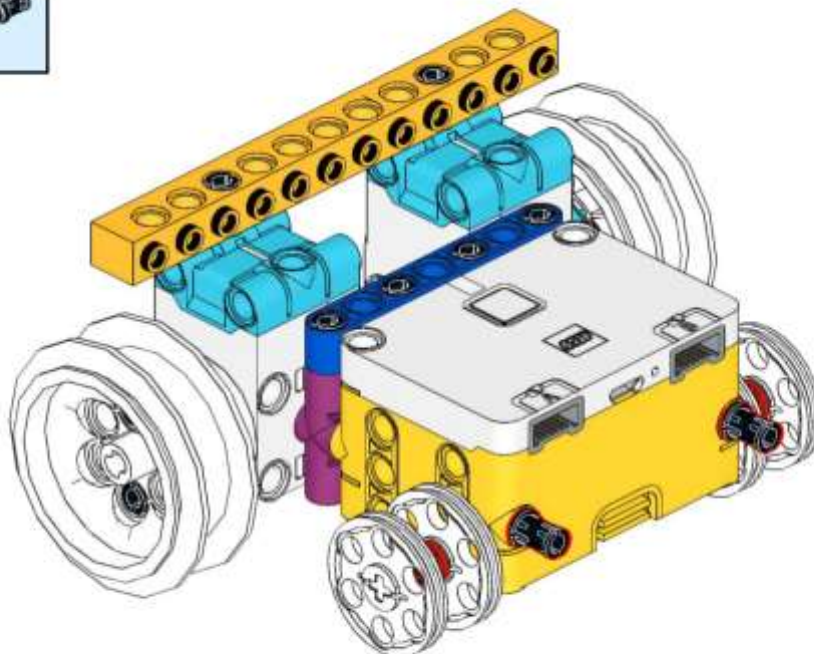

23

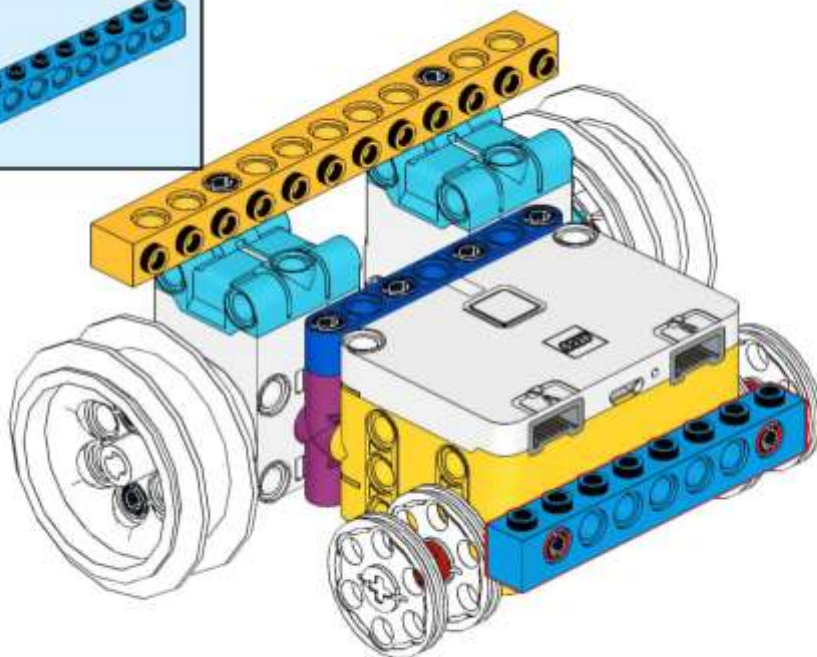
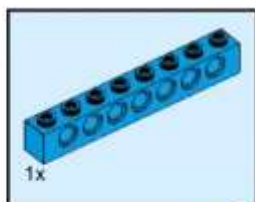

24

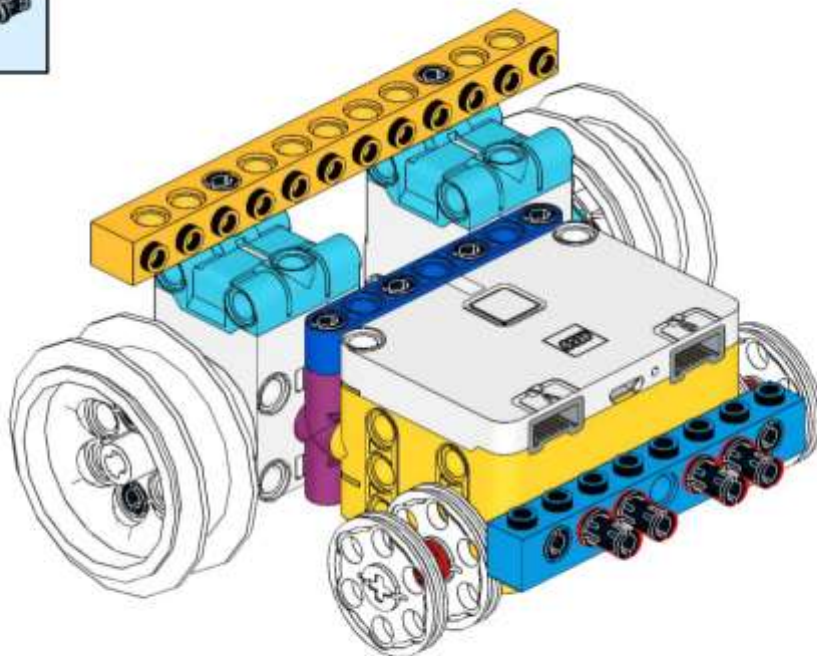

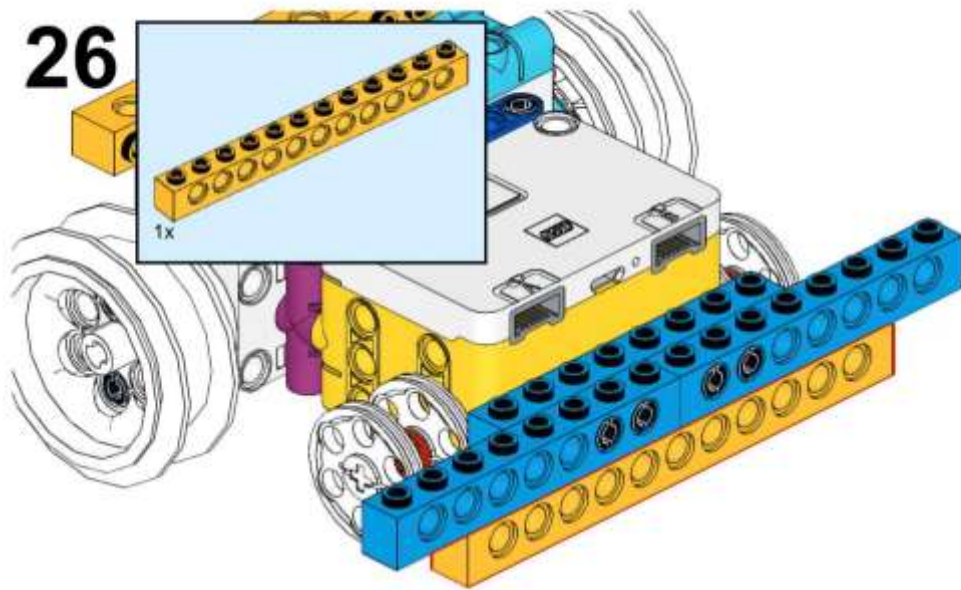
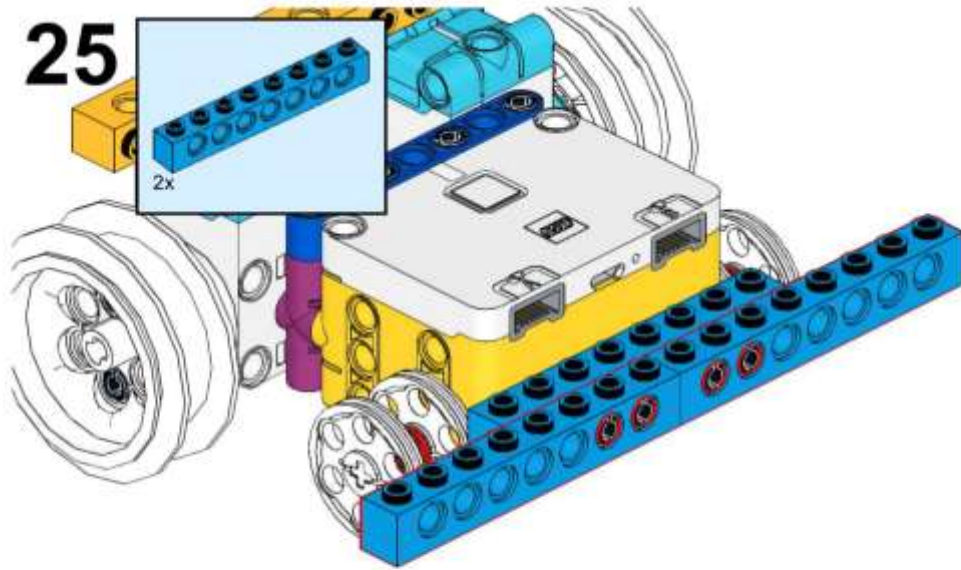

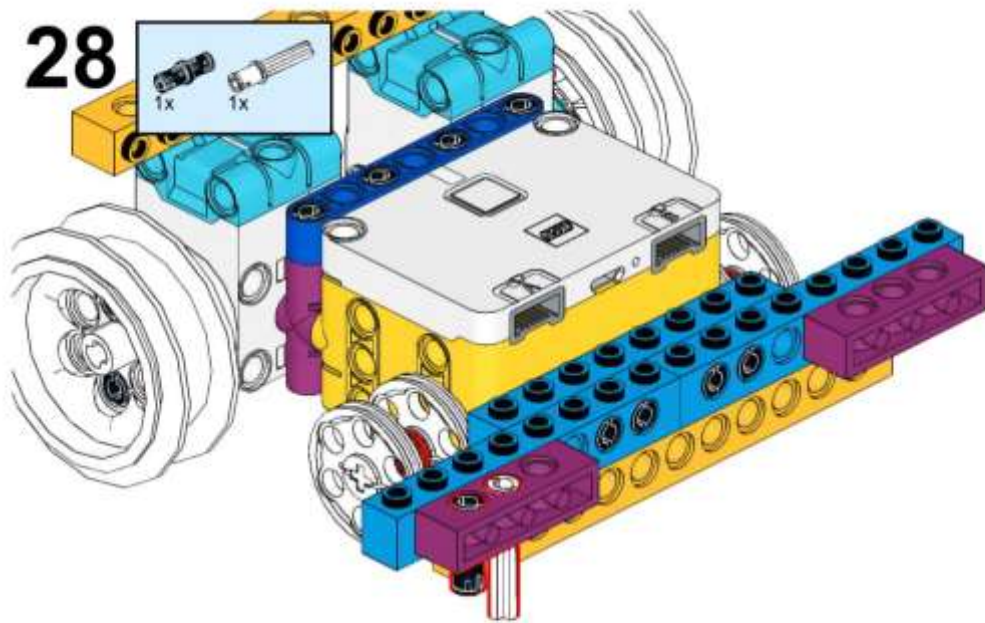
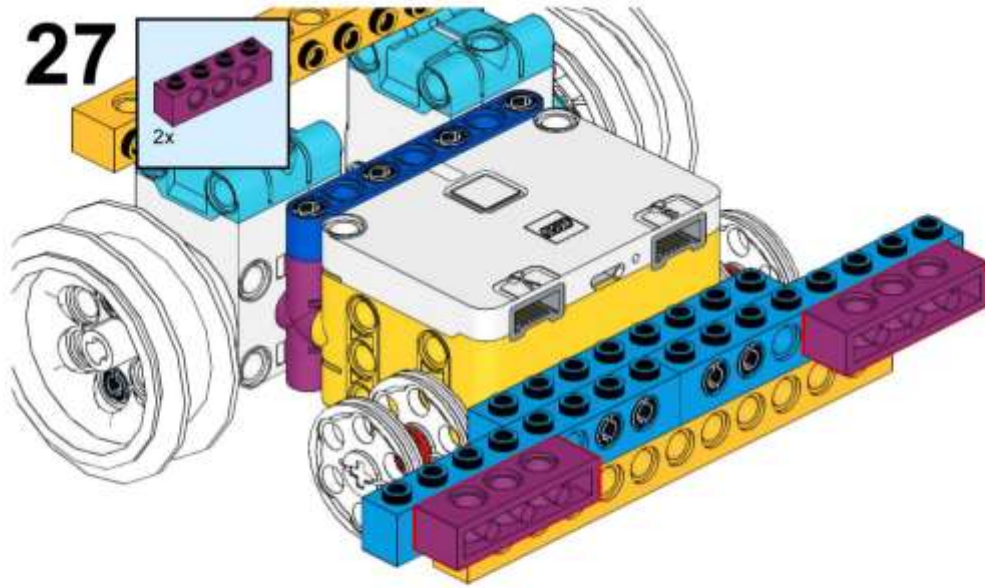

29

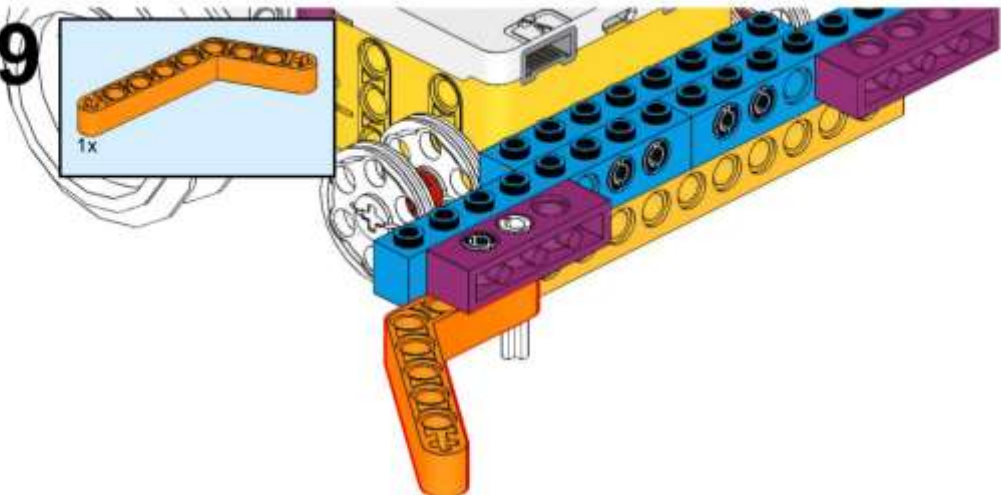
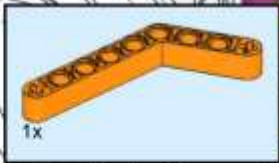

30

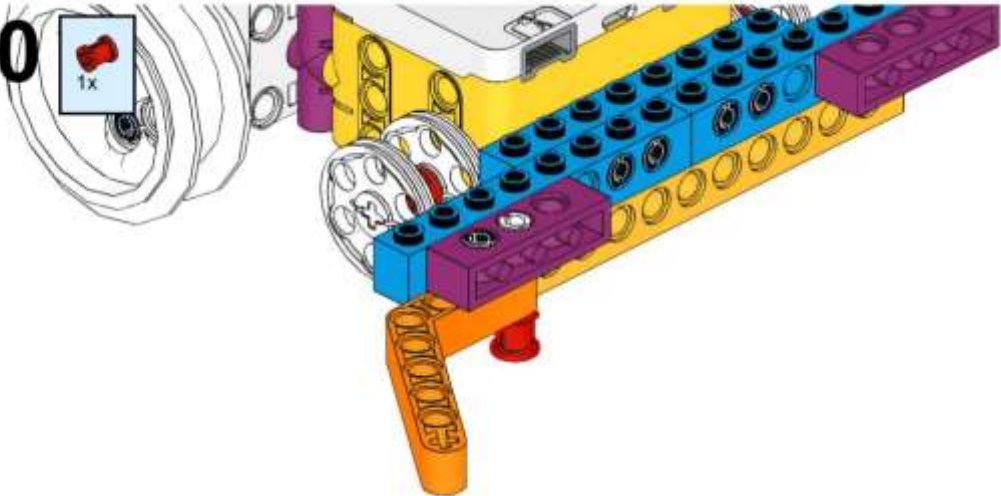

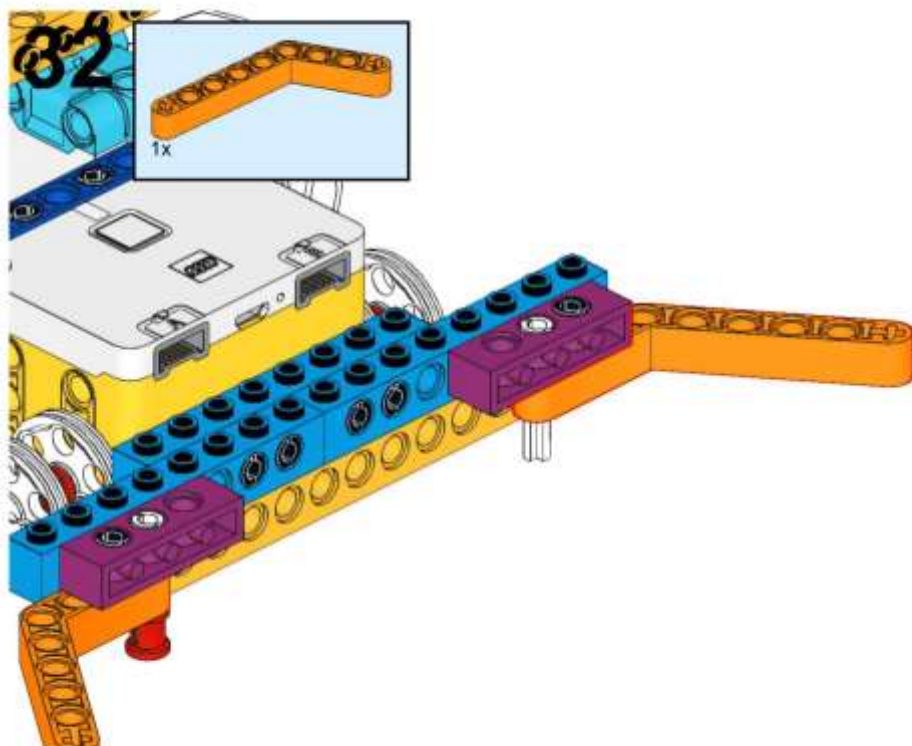
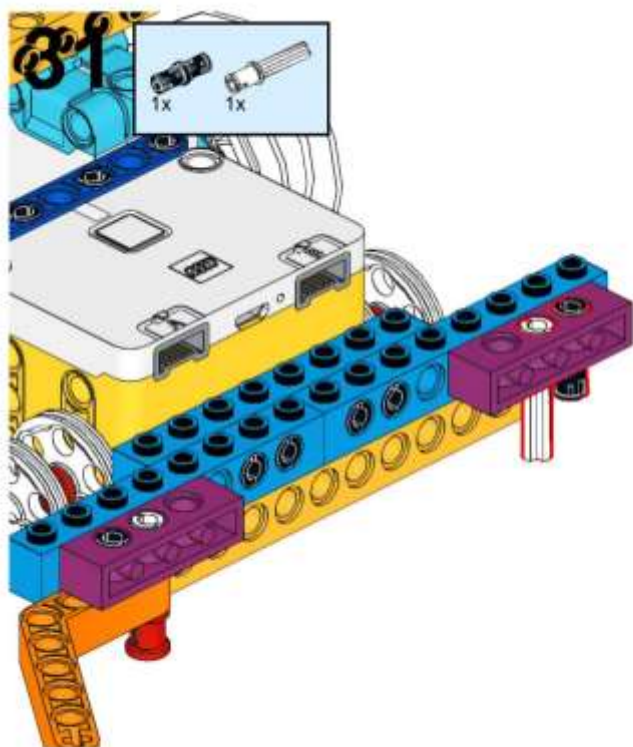

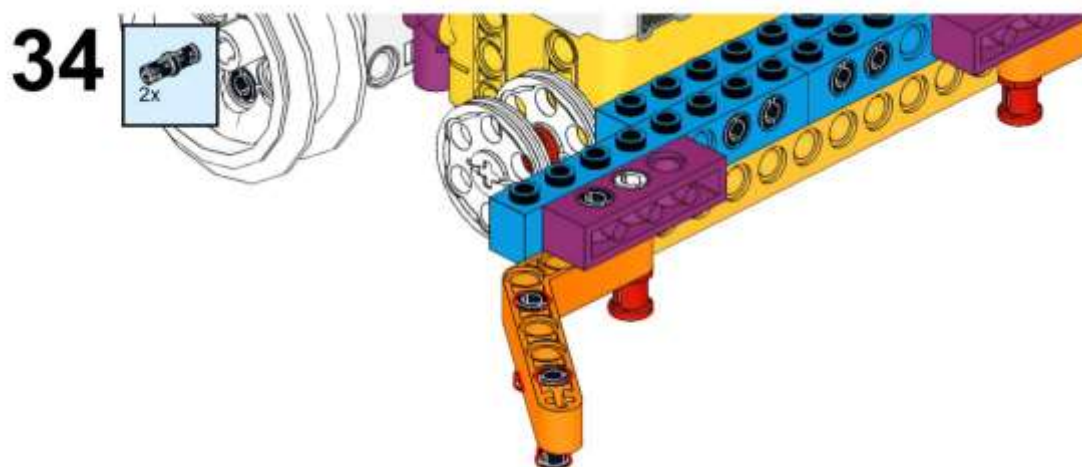
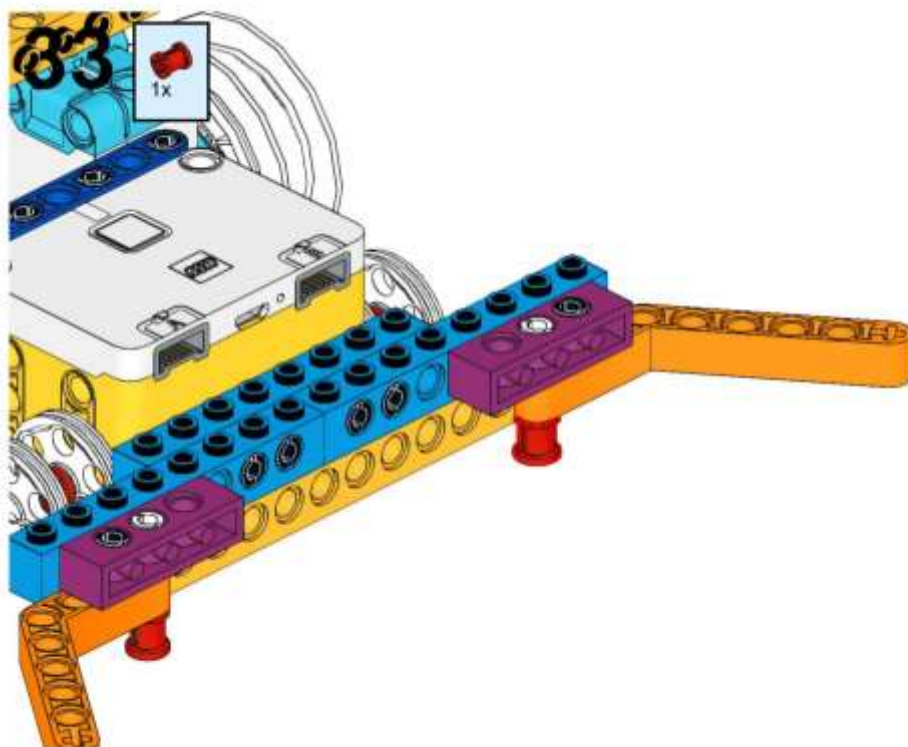

35

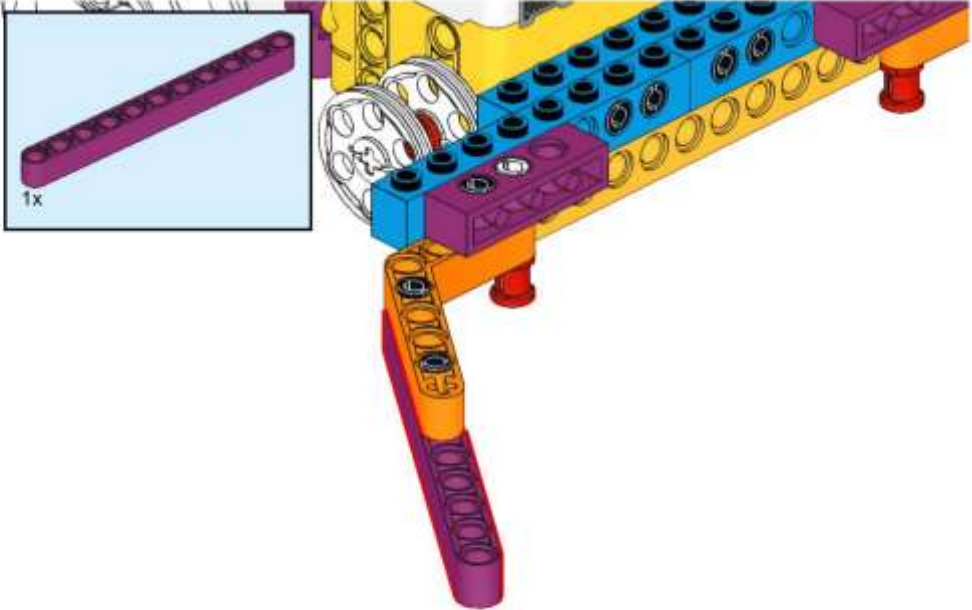

36

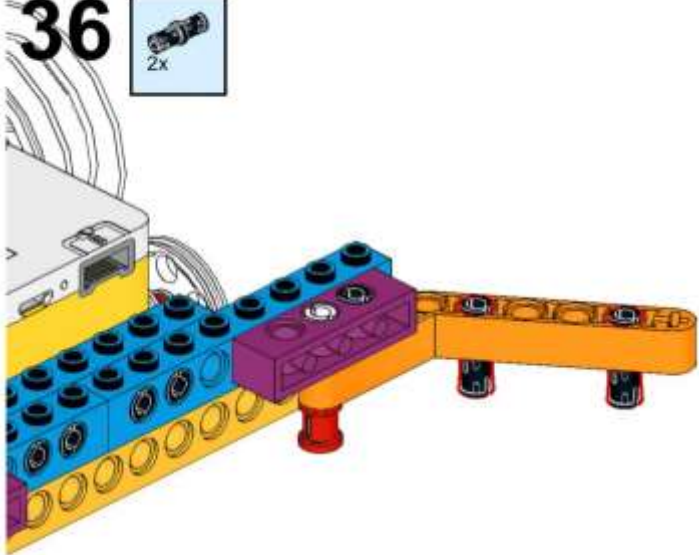

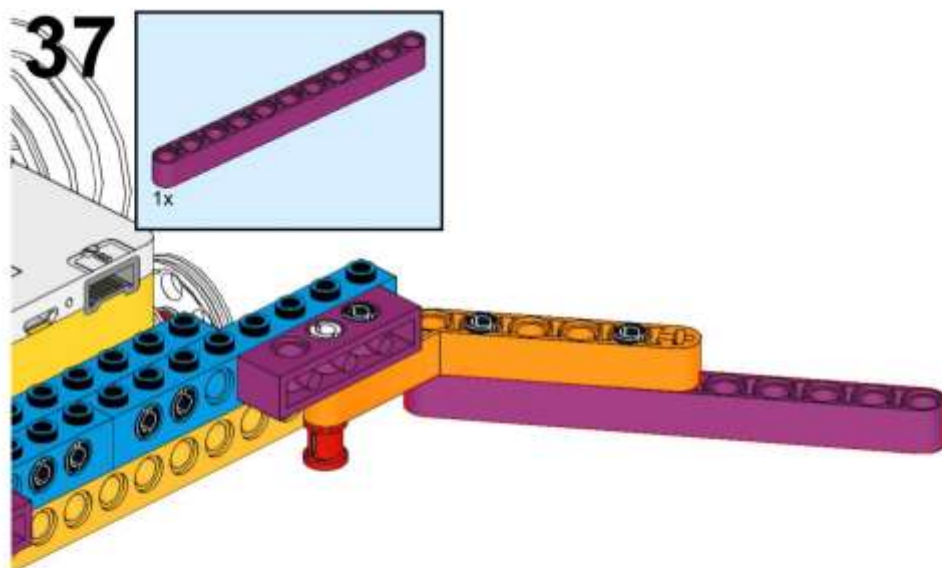

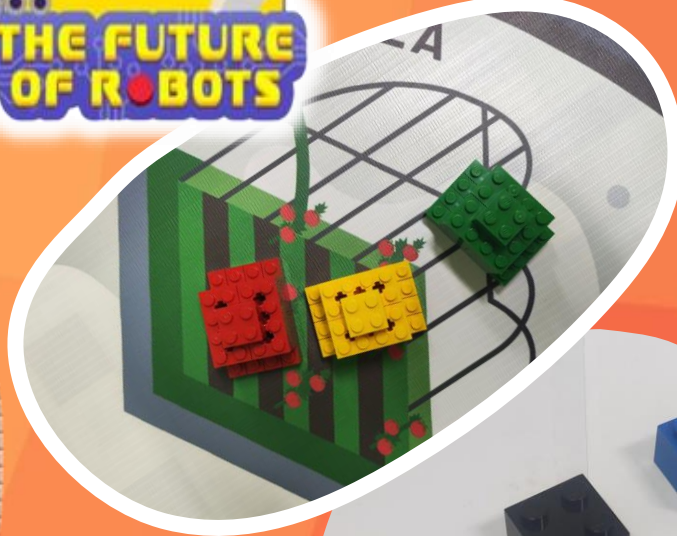

**NETD**

MINISTRY OF EDUCATION, INNOVATION  
& TALENT DEVELOPMENT, SARAWAK

PEMERINTAH PENDIDIKAN, INOVASI DAN PEMBANGUNAN SARAWAK



**INSTITUT PENDIDIKAN GURU  
KAMPUS SARAWAK**

e ISBN 978-967-2830-81-8



9 789672 830818